

| | | | | | |
|---------|-----|------------|---------|-----------|-----|
| HOMBRES | | RESULTADOS | | MINIMOSCA | |
| HOMMES | MEN | RESULTATS | RESULTS | MI-MOUCHE | FIN |

-43 KG

| | |
|-------------|---------|
| COMPETIDOR | PAIS |
| COMPETITEUR | PAYS |
| COMPETITOR | COUNTRY |

| | | | | | |
|-----------------------|-----|-----|----|-----|-----|
| TORALDO UITO | ITA | ITA | | | |
| LAI VO | USA | USA | 03 | 1/8 | |
| GUERRERO JULIO CESAR | PER | PER | | | JPN |
| HATTORI DAISUKE | JPN | JPN | 03 | 3/1 | |
| CHIN WEN CHEN | CHI | CHI | | | KOR |
| MORENO DODDOLI CARLOS | MEX | MEX | 03 | 5/4 | |
| JEONG OH KIM | KOR | KOR | | | KOR |
| AHMAD SHUKOR SAAD | MAL | MAL | 03 | 8/8 | |

| | |
|-----------|---------|
| GANADORES | |
| GAGNANTS | WINNERS |

- 1.- JEONG OH KIM KOR
- 2.- HATTORI DAISUKE JPN
- 3.- CARLOS MORENO D. MEX
- 3.- TORALDO UITO ITA

| | | | | | |
|-------------------------------------|----------------------|--|-----------------------------------|--|--|
| 01 KNOX OUT KNOX OUT KNOX OUT | 02 RSC RSC RSC | 03 PUNTOS/SUPERIORIDAD POINT /SUPERIORITE POINTS/SUPERIORITY | 04 RETIRO RETRAITÉ WITHDRAW | 05 DESCALIFICACION DISQUALIFICATION DISQUALIFIED | 06 DEDUCCION DEDUCCION DEDUCCION |
|-------------------------------------|----------------------|--|-----------------------------------|--|--|

| | | | | | |
|---------|-----|------------|---------|--------|-----|
| HOMBRES | | RESULTADOS | | MOSCA | |
| HOMMES | MEN | RESULTATS | RESULTS | MOUCHE | FLY |

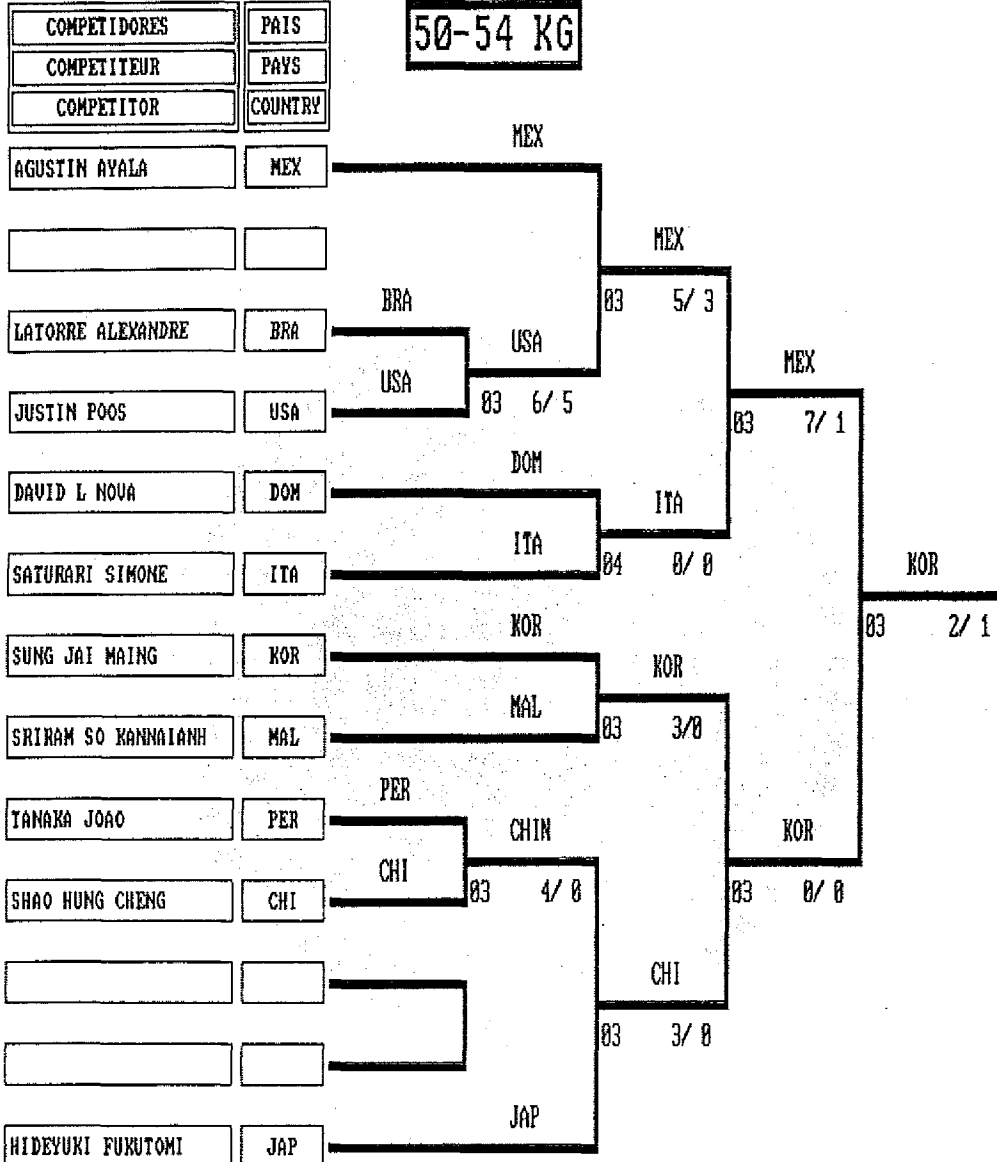

- 1.- SUNG JAI MAING KOR
- 2.- AYALA YEE AGUSTIN MEX
- 3.- SHAO HUNG CHENG CHI
- 3.- STURARI SIMONE ITA

| | | | | | |
|-------------------------------------|----------------------|--|-----------------------------------|--|--|
| 01 KNOX OUT KNOX OUT KNOX OUT | 02 RSC RSC RSC | 03 PUNTOS/SUPERIORIDAD POINTS/SUPERIORITY POINT /SUPERIORITE | 04 RETIRO WITHDRAW RETRAITE | 05 DESCALIFICACION DISQUALIFIED DISQUALIFICATION | 06 DEDUCCION DEDUCCION DEDUCTION |
|-------------------------------------|----------------------|--|-----------------------------------|--|--|

| | | | | | |
|---------|-----|------------|---------|-------|--------|
| HOMBRES | | RESULTADOS | | GALLO | |
| HOMMES | MEN | RESULTATS | RESULTS | COQ | BANTAM |

54-58 KG

| | |
|--------------|---------|
| COMPETIDORES | PAIS |
| COMPETITEUR | PAYS |
| COMPETITOR | COUNTRY |

| | | | | | |
|------------------------|-----|-----|-----|-----|-----|
| HIRONOBU YAMASHITA | JPN | | | | |
| MARCIAL BASANTA LOPEZ | CUB | CUB | CUB | 03 | 7/2 |
| HECTOR RODRIGUEZ | DOM | DOM | 04 | 0/0 | |
| BYUNG UK KIM | KOR | KOR | | | |
| ELIO S NIYAMOTO | BRA | BRA | 03 | 3/0 | |
| | | | | | |
| YU HUAN CHEN | CHI | CHI | | | |
| | | | | | |
| ELBERT KIM | USA | USA | 03 | 4/4 | |
| | | | | | |
| NESTOR RAUL SOLORIZANO | ECU | ECU | | | |
| | | | | | |
| RAFAEL ZUNIGA | MEX | MEX | 03 | 5/2 | |

| | |
|-----------|---------|
| GANADORES | |
| GAGNANTS | WINNERS |

- 1.- BYUNG UK KIM KOR
- 2.- RAFAEL ZUNIGA MEX
- 3.- MARCIAL BASANTA CUB
- 3.- ELBERT KIM USA

| | | | | | |
|-------------------------------------|----------------------|--|-----------------------------------|--|--------------------------------------|
| 01 KNOX OUT KNOX OUT KNOX OUT | 02 RSC RSC RSC | 03 PUNTOS/SUPERIORIDAD POINTS/SUPERIORITY POINT /SUPERIORITE | 04 RETIRO WITHDRAW RETRAITE | 05 DESCALIFICACION DISQUALIFIED DISQUALIFICATION | 06 DEUCCION DEUCCION DEDUCTION |
|-------------------------------------|----------------------|--|-----------------------------------|--|--------------------------------------|

| | | | | | |
|---------|-----|------------|---------|-------|---------|
| HOMBRES | | RESULTADOS | | PLUMA | |
| HOMMES | MEN | RESULTATS | RESULTS | PLUME | FEATHER |

58-64 KG

| | |
|--------------|---------|
| COMPETIDORES | PAIS |
| COMPETITEUR | PAYS |
| COMPETITOR | COUNTRY |

| | | | | | | | | | |
|-----------------------|-----|-----|-----|----|-----|--|--|-----|-----|
| HONG YOUB AN | KOR | | | | | | | | |
| | | KOR | | | | | | | |
| RAPHAEL MIN PARK | USA | USA | | | | | | | |
| | | | CHI | 03 | 6/2 | | | | |
| CHAO SENG PANG | CHI | CHI | | 03 | 5/3 | | | | |
| | | | JPN | | | | | KOR | |
| HIROYUKI YAMASHITA | JPN | | | | | | | 04 | 1/1 |
| | | | JPN | | | | | | |
| | | | GRE | 03 | 5/3 | | | | |
| SPIROS BADAS | GRE | | | | | | | | |
| | | | BRA | | | | | KOR | |
| WEINMANN ANDRE | BRA | | | | | | | 03 | 5/3 |
| | | | MEX | | | | | | |
| FERNANDO DORANTES | MEX | | | | | | | | |
| | | | MEX | 03 | 6/4 | | | | |
| | | | PER | 03 | 2/2 | | | | |
| GIAN CARLOS WEISS | PER | | | | | | | | |
| | | | ECU | | | | | ESP | |
| JULIO ENRIQUE FAJARDO | ECU | | | | | | | 03 | 3/0 |
| | | | ECU | | | | | | |
| | | | CAN | 01 | 0/0 | | | | |
| WAYOM KENDALL | CAN | | | | | | | | |
| | | | ESP | 05 | 3/3 | | | | |
| VALENTIN SANCHEZ | ESP | | | | | | | | |

GANADORES

| | |
|----------|---------|
| GAGNANTS | WINNERS |
|----------|---------|

- 1.- HONG YOUB AN KOR
- 2.- VALENTIN SANCHEZ ESP
- 3.- HIROYUKI YAMASHITA JPN
- 3.- FERNANDO DORANTES MEX

01 KNOX OUT
KNOX OUT
KNOX OUT

02 RSC
RSC
RSC

03 PUNTOS/SUPERIORIDAD
POINTS/SUPERIORITY
POINT /SUPERIORITE

04 RETIRO
WITHDRAW
RETRAITE

05 DESCALIFICACION
DISQUALIFIED
DISQUALIFICATION

06 DEDUCCION
DEDUCCION
DEDUCTION

| | | | | | |
|---------|-----|------------|---------|--------|-------|
| HOMBRES | | RESULTADOS | | LIGERO | |
| HOMMES | MEN | RESULTATS | RESULTS | LEGER | LIGHT |

64-70 KG

| | |
|--------------|---------|
| COMPETIDORES | PAIS |
| COMPETITEUR | PAYS |
| COMPETITOR | COUNTRY |

| | | | | | | | | | |
|---------------------|-----|-----|-----|-----|-----|--|--|--|--|
| PASCUAL CANO | ESP | | | | | | | | |
| ELEFTHERIOS GLANTAS | GRE | ESP | ESP | 04 | 0/0 | | | | |
| DOUGLAS BAKER | USA | USA | 03 | 5/4 | | | | | |
| SHUHEI KAWAMURA | JPN | JPN | 03 | 3/0 | | | | | |
| CHENG HUNG WEI | CHI | CHI | 03 | 6/1 | | | | | |
| JULIO ALVAREZ | MEX | MEX | 03 | 5/0 | | | | | |
| SE JIN PARK | KOR | KOR | 03 | 5/0 | | | | | |
| ALFREDO OLIVER | PER | PER | | | | | | | |
| AXEL LEGAI | BEL | BEL | 03 | 4/1 | | | | | |
| ROBERTO ABREU | CUB | CUB | 03 | 3/3 | | | | | |
| FALK HOFF | ALE | ALE | 03 | 5/3 | | | | | |
| FABIO SILVA | BRA | BRA | 03 | 4/3 | | | | | |
| VICTOR LUKE | CAN | CAN | 03 | 5/3 | | | | | |

GANADORES

| | |
|----------|---------|
| GAGNANTS | WINNERS |
|----------|---------|

- | | |
|-------------------|-----|
| 1.- SE JIN PARK | KOR |
| 2.- ROBERTO ABREU | CUB |
| 3.- PASCUAL CANO | ESP |
| 3.- VICTOR LUKE | CAN |

01 KNOCK OUT
KNOCK OUT
KNOCK OUT

02 RSC
RSC
RSC

03 PUNTOS/SUPERIORIDAD
POINTS/SUPERIORITY
POINT /SUPERIORITE

04 RETIRO
WITHDRAW
RETRAITE

05 DESCALIFICACION
DISQUALIFIED
DISQUALIFICATION

06 DEDUCCION
DEDUCCION
DEDUCTION

| | | | | | |
|---------|-----|------------|---------|-------------|--------|
| HOMBRES | | RESULTADOS | | SUPERLIGERO | |
| HOMMES | MEN | RESULTATS | RESULTS | MI-MOYEN | WELTER |

70-76 KG

| | |
|--------------|---------|
| COMPETIDORES | PAIS |
| COMPETITEUR | PAYS |
| COMPETITOR | COUNTRY |

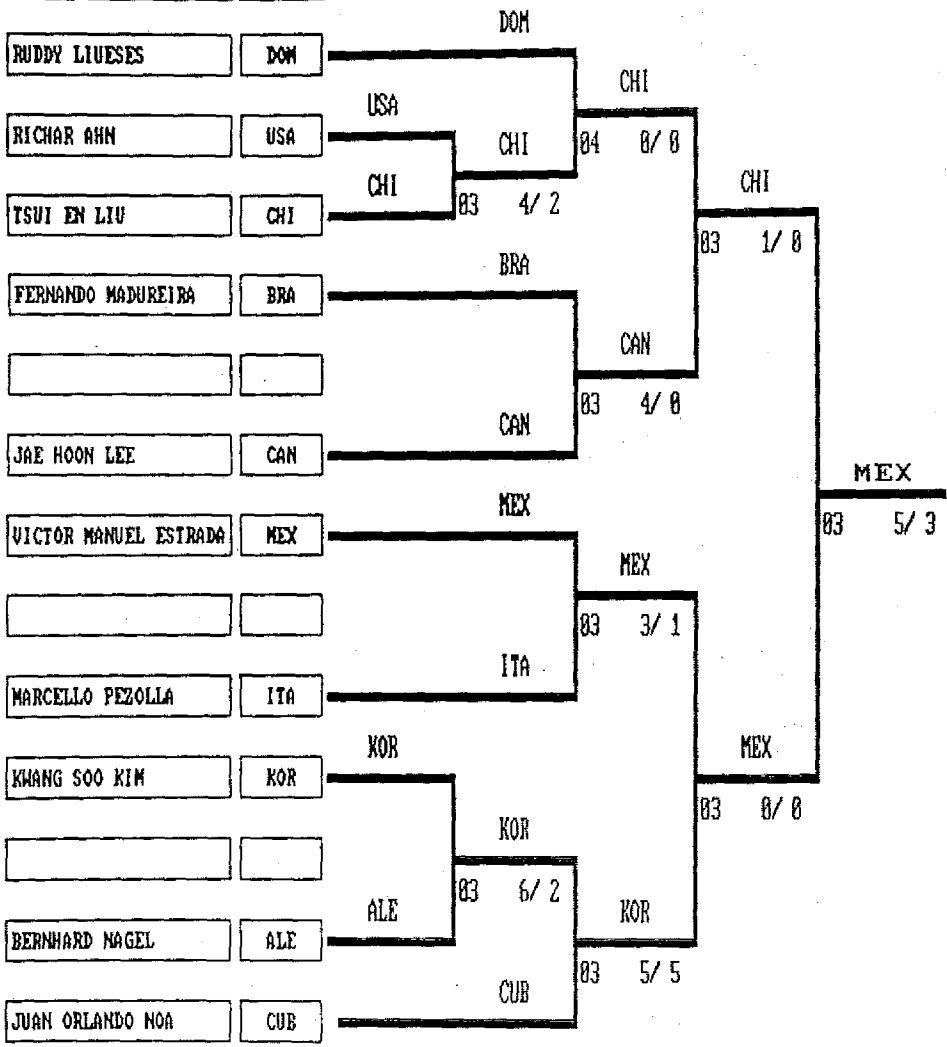

| | |
|-----------|---------|
| GANADORES | |
| GAGNANTS | WINNERS |

- 1.- VICTOR M ESTRADA MEX
- 2.- TSU I EN LIU CHI
- 3.- KWANG SOO KIM KOR
- 3.- JAE HOON LEE CAN

| | | | | | |
|-------------------------------------|----------------------|--|-----------------------------------|--|--|
| 81 KNOX OUT KNOX OUT KNOX OUT | 82 RSC RSC RSC | 83 PUNTOS/SUPERIORIDAD POINTS/SUPERIORITY POINT /SUPERIORITE | 84 RETIRO WITHDRAW RETRAITE | 85 DESCALIFICACION DISQUALIFIED DISQUALIFICATION | 86 DEDUCCION DEDUCCION DEDUCCION |
|-------------------------------------|----------------------|--|-----------------------------------|--|--|

| | | | | | |
|---------|-----|------------|---------|--------|-------|
| HOMBRES | | RESULTADOS | | PESADO | |
| HOMMES | MEN | RESULTATS | RESULTS | LOURD | HEAVY |

+83 KG

| | |
|-------------|---------|
| COMPETIDOR | PAIS |
| COMPETITEUR | PAYS |
| COMPETITOR | COUNTRY |

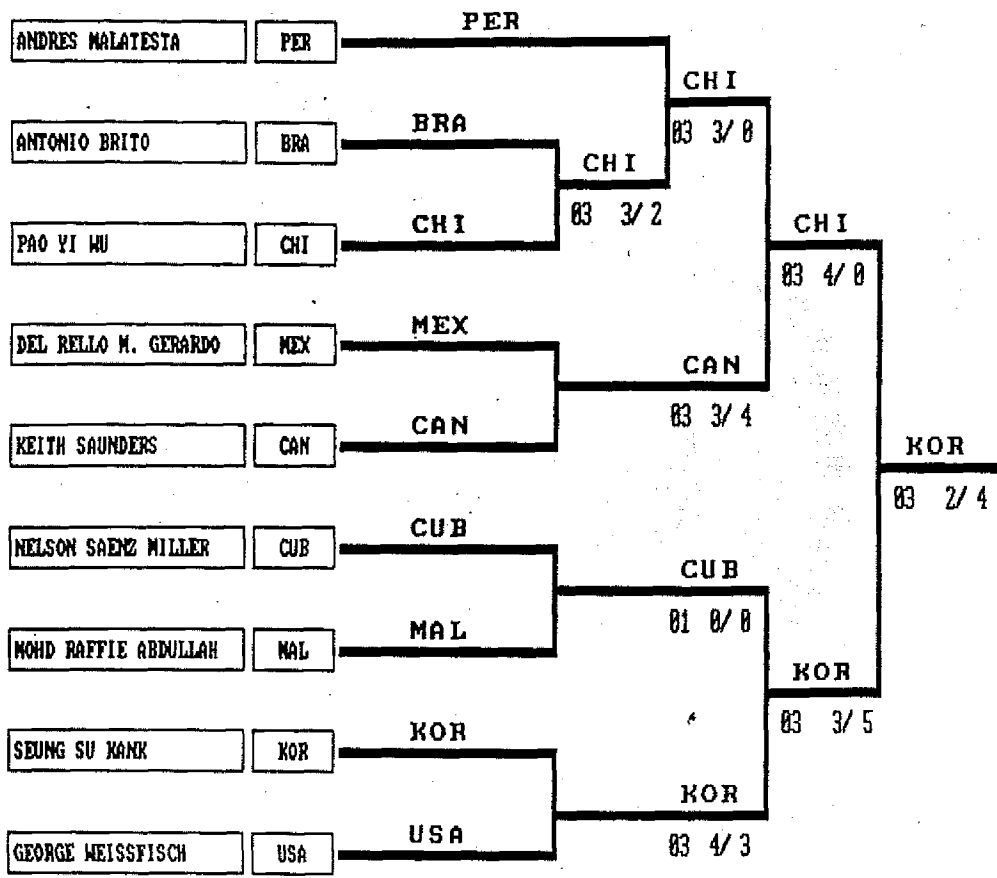

GANADORES

| | |
|----------|---------|
| GAGNANTS | WINNERS |
|----------|---------|

- 1.- SEUNG SU KANG KOR
- 2.- PAO YI WU CHI
- 3.- NELSON SAENZ MILLER CUB
- 3.- KEITH SAUNDERS CAN

| | | | | | |
|--|----------------------|--|-----------------------------------|--|--|
| 81 KNOCK OUT KNOCK OUT KNOCK OUT | 82 RSC RSC RSC | 83 PUNTOS/SUPERIORIDAD POINT /SUPERIORITE POINTS/SUPERIORITY | 84 RETIRO RETRAITE WITHDRAW | 85 DESCALIFICACION DISQUALIFICATION DISQUALIFIED | 86 DEDUCCION DEDUCTION DEDUCCION |
|--|----------------------|--|-----------------------------------|--|--|

| | | | | | |
|---------|-------|------------|---------|-----------|-----|
| MUJERES | | RESULTADOS | | MINIMOSCA | |
| DAMES | WOMEN | RESULTATS | RESULTS | MI-MOUCHE | FIN |

-43 KG

| | |
|-------------|---------|
| COMPETIDOR | PAIS |
| COMPETITEUR | PAYS |
| COMPETITOR | COUNTRY |

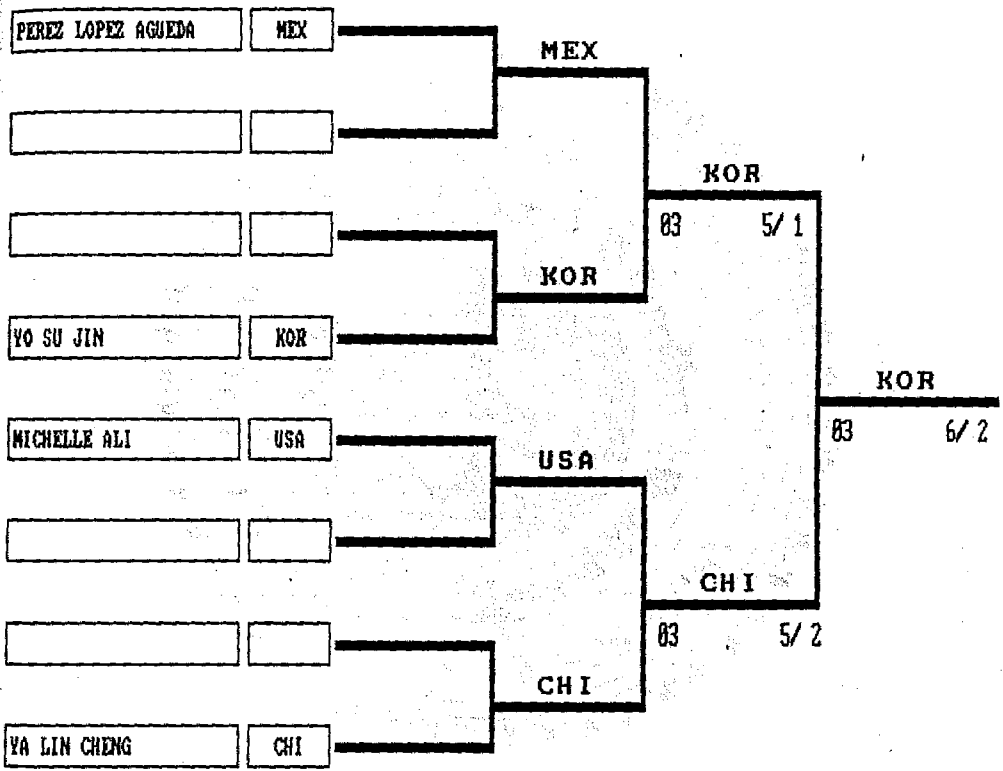

| | |
|-----------|---------|
| GANADORES | |
| GAGNANTS | WINNERS |

- | | |
|------------------|-----|
| 1.- YOU SU JIN | KOR |
| 2.- YA LIN CHENG | CHI |
| 3.- AGUEDA PEREZ | MEX |
| 3.- MICHELLE ALI | USA |

| | | | | | |
|-------------------------------------|----------------------|--|-----------------------------------|--|--|
| 01 KNOX OUT KNOX OUT KNOX OUT | 02 RSC RSC RSC | 03 PUNTOS/SUPERIORIDAD POINT /SUPERIORITE POINTS/SUPERIORITY | 04 RETIRO RETRAITE WITHDRAW | 05 DESCALIFICACION DISQUALIFICATION DISQUALIFIED | 06 DEDUCCION DEDUCTION DEDUCCION |
|-------------------------------------|----------------------|--|-----------------------------------|--|--|



| | | | | | |
|---------|-------|------------|---------|-------|--------|
| MUJERES | | RESULTADOS | | GALLO | |
| DAMES | WOMEN | RESULTATS | RESULTS | COQ | BANTAM |

47-51 KG

| | |
|-------------|---------|
| COMPETIDOR | PAIS |
| COMPETITEUR | PAYS |
| COMPETITOR | COUNTRY |

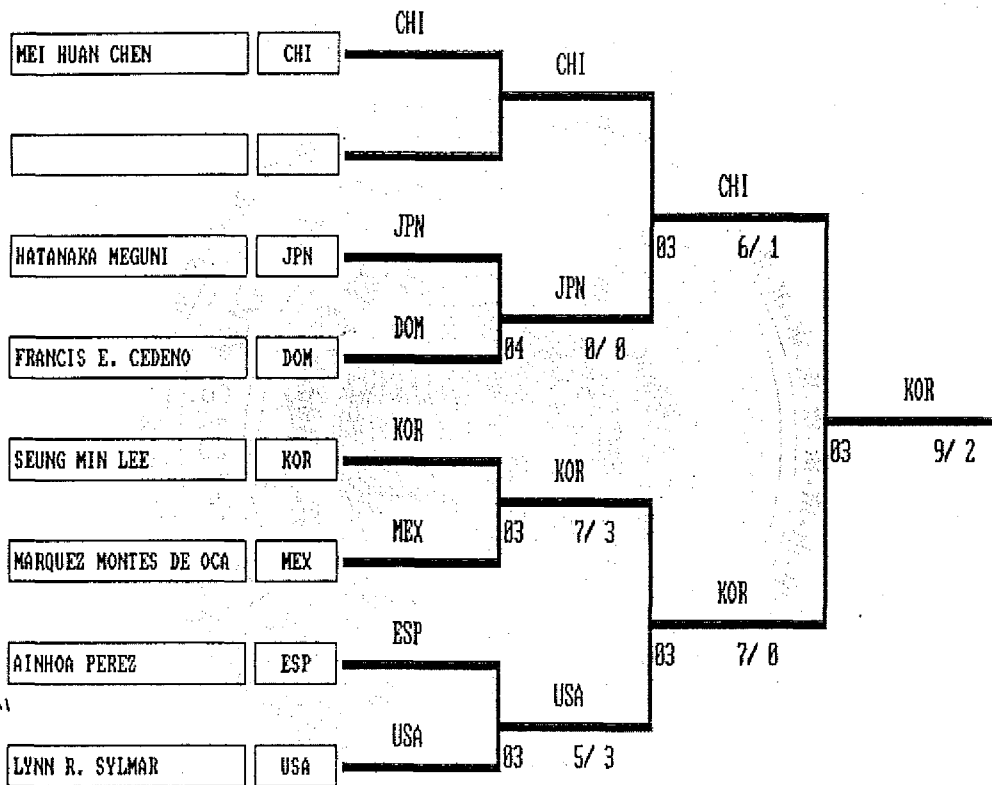

| | |
|-----------|---------|
| GANADORES | |
| GAGNANTS | WINNERS |

- 1.- SEUNG MIN LEE KOR
- 2.- MEI HUA CHEN CHI
- 3.- HATANAKA MEGUMI JPN
- 3.- LYNN R SYLMAR USA

01 KNOK OUT
KNOK OUT
KNOK OUT

02 RSC
RSC
RSC

03 PUNTOS/SUPERIORIDAD
POINT /SUPERIORITE
POINTS/SUPERIORITY

04 RETIRO
RETRAITE
WITHDRAW

05 DESCALIFICACION
DISQUALIFICATION
DISQUALIFIED

06 DEDUCCION
DEDUCCION
DEDUCCION

| | | | | | |
|---------|-------|------------|---------|-------|---------|
| MUJERES | | RESULTADOS | | PLUMA | |
| DAMES | WOMEN | RESULTATS | RESULTS | PLUME | FEATHER |

51-55 KG

| | |
|-------------|---------|
| COMPETIDOR | PAIS |
| COMPETITEUR | PAYS |
| COMPETITOR | COUNTRY |

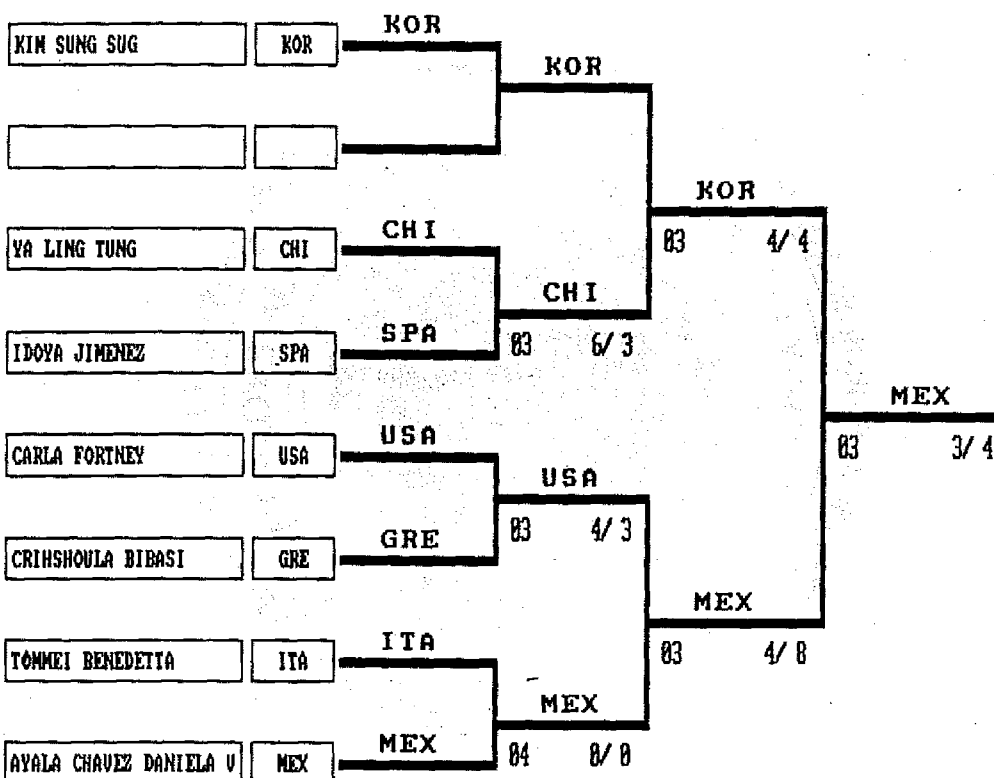

| | |
|-----------|---------|
| GANADORES | |
| GAGNANTS | WINNERS |

- 1.- DANIELA U. CHAVEZ A. MEX
- 2.- KIM SUNG SUG KOR
- 3.- CARLA FORTNEY USA
- 3.- YA LING TUNG CHI

| | | | | | |
|--|----------------------|--|-----------------------------------|--|--|
| 01 KNOCK OUT KNOCK OUT KNOCK OUT | 02 RSC RSC RSC | 03 PUNTOS/SUPERIORIDAD POINT /SUPERIORITE POINTS/SUPERIORITY | 04 RETIRO RETRAITE WITHDRAW | 05 DESCALIFICACION DISQUALIFICATION DISQUALIFIED | 06 DEDUCCION DEDUCCION DEDUCCION |
|--|----------------------|--|-----------------------------------|--|--|

| | | | | | |
|---------|-------|------------|---------|--------|-------|
| MUJERES | | RESULTADOS | | LIGERO | |
| DAMES | WOMEN | RESULTATS | RESULTS | LEGER | LIGHT |

55-60 KG

| | |
|-------------|---------|
| COMPETIDOR | PAIS |
| COMPETITEUR | PAYS |
| COMPETITOR | COUNTRY |

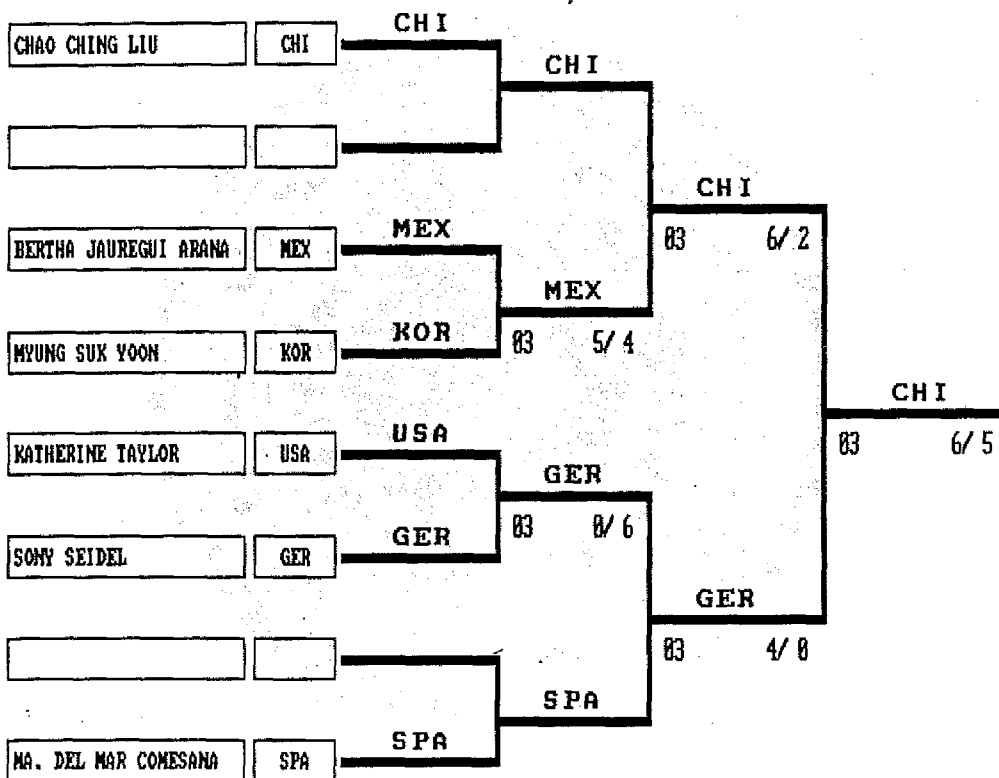

| | |
|-----------|---------|
| GANADORES | |
| GAGNANTS | WINNERS |

- | | |
|------------------------|-----|
| 1.- CHAO CHING LIU | CHI |
| 2.- SONY SEIDEL | GER |
| 3.- BERTHA JAUREGUI A. | MEX |
| 3.- MA DEL COMESANA R. | SPA |

| | | | | | |
|-------------------------------------|----------------------|--|-----------------------------------|--|--|
| 01 KNOX OUT KNOX OUT KNOX OUT | 02 RSC RSC RSC | 03 PUNTOS/SUPERIORIDAD POINT /SUPERIORITE POINTS/SUPERIORITY | 04 RETIRO RETRAITE WITHDRAW | 05 DESCALIFICACION DISQUALIFICATION DISQUALIFIED | 06 DEDUCCION DEDUCCION DEDUCCION |
|-------------------------------------|----------------------|--|-----------------------------------|--|--|

| | | | | | |
|---------|-------|------------|---------|-------------|--------|
| MUJERES | | RESULTADOS | | SUPERLIGERO | |
| DAMES | WOMEN | RESULTATS | RESULTS | MI-MOYEN | WELTER |

60-65 KG

| | |
|--------------|---------|
| COMPETIDORES | PAIS |
| COMPETITEUR | PAYS |
| COMPETITOR | COUNTRY |

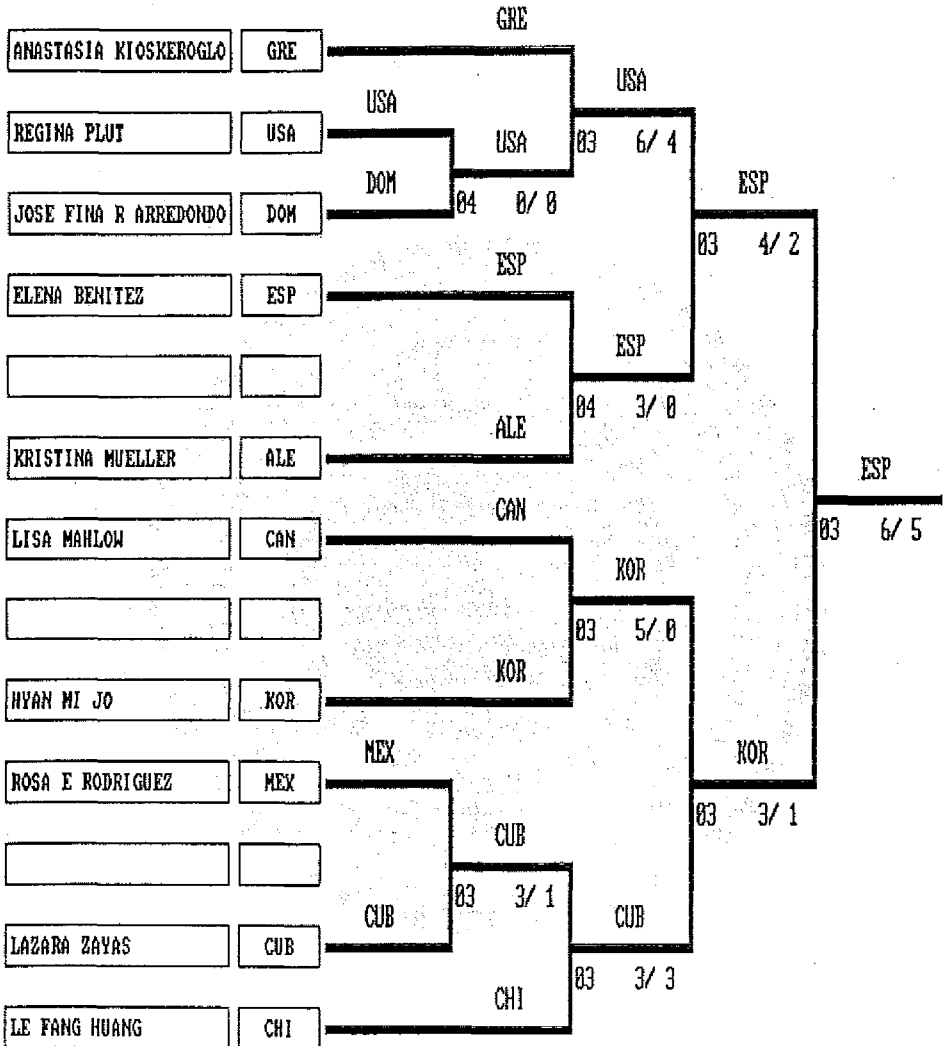

GANADORES

| | |
|----------|---------|
| GAGNANTS | WINNERS |
|----------|---------|

- 1.- ELENA BENITEZ M ESP
- 2.- HYANG MI JO KOR
- 3.- LAZARA C ZALLAS CUB
- 3.- REGINA PLUTH USA

| | | | | | |
|-------------------------------------|----------------------|--|-----------------------------------|--|--|
| 01 KNOK OUT KNOK OUT KNOK OUT | 02 RSC RSC RSC | 03 PUNTOS/SUPERIORIDAD POINTS/SUPERIORITY POINT /SUPERIORITE | 04 RETIRO WITHDRAW RETRAITE | 05 DESCALIFICACION DISQUALIFIED DISQUALIFICATION | 06 DEDUCCION DEDUCCION DEDUCCION |
|-------------------------------------|----------------------|--|-----------------------------------|--|--|

MUJERES

RESULTADOS

MEDIO

DAMES WOMEN

RESULTATS RESULTS

MOYEN MIDDLE

65-70 KG

| | |
|-------------|---------|
| COMPETIDOR | PAIS |
| COMPETITEUR | PAYS |
| COMPETITOR | COUNTRY |

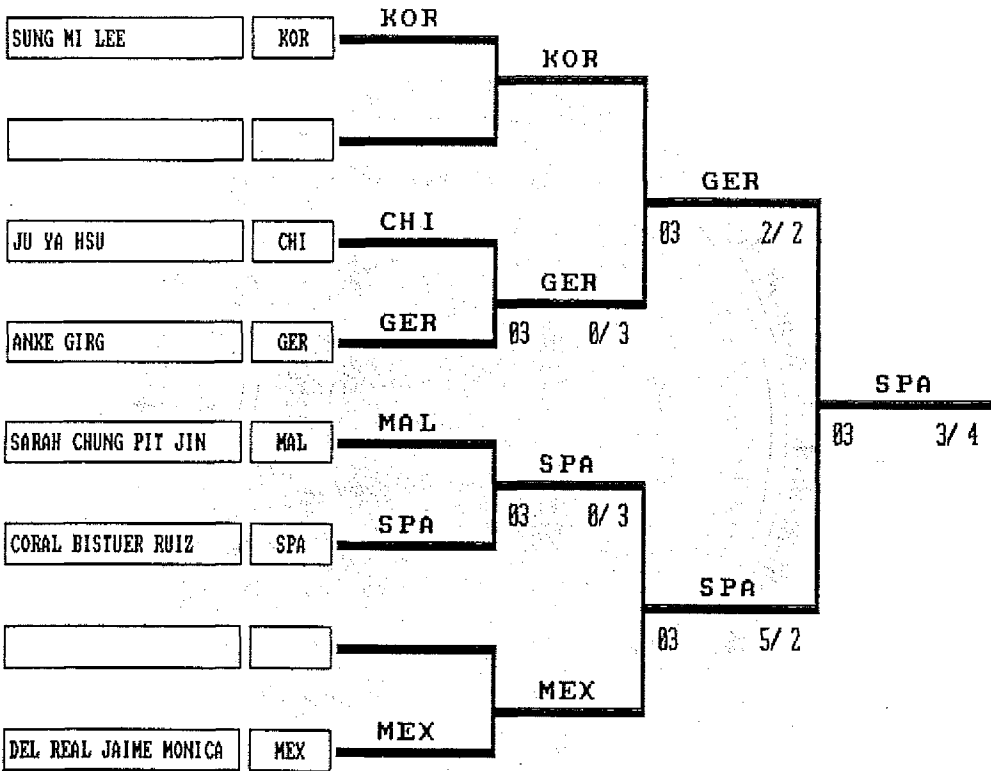

GANADORES

GAGNANTS

WINNERS

- 1.- CORAL BISTUER RUIZ SPA
- 2.- ANKE GIRG GER
- 3.- MONICA DEL REAL J. MEX
- 3.- SUNG MI LEE KOR

01 KNOK OUT
KNOK OUT
KNOK OUT

02 RSC
RSC
RSC

03 PUNTOS/SUPERIORIDAD
POINT /SUPERIORITE
POINTS/SUPERIORITY

04 RETIRO
RETRAITE
WITHDRAW

05 DESCALIFICACION
DISQUALIFICATION
DISQUALIFIED

06 DEDUCCION
DEDUCCION
DEDUCCION

| | | | | | |
|---------|-------|------------|---------|--------|-------|
| MUJERES | | RESULTADOS | | PESADO | |
| DAMES | WOMEN | RESULTATS | RESULTS | LOURD | HEAVY |

+70 KG

| | |
|-------------|---------|
| COMPETIDOR | PAIS |
| COMPETITEUR | PAYS |
| COMPETITOR | COUNTRY |

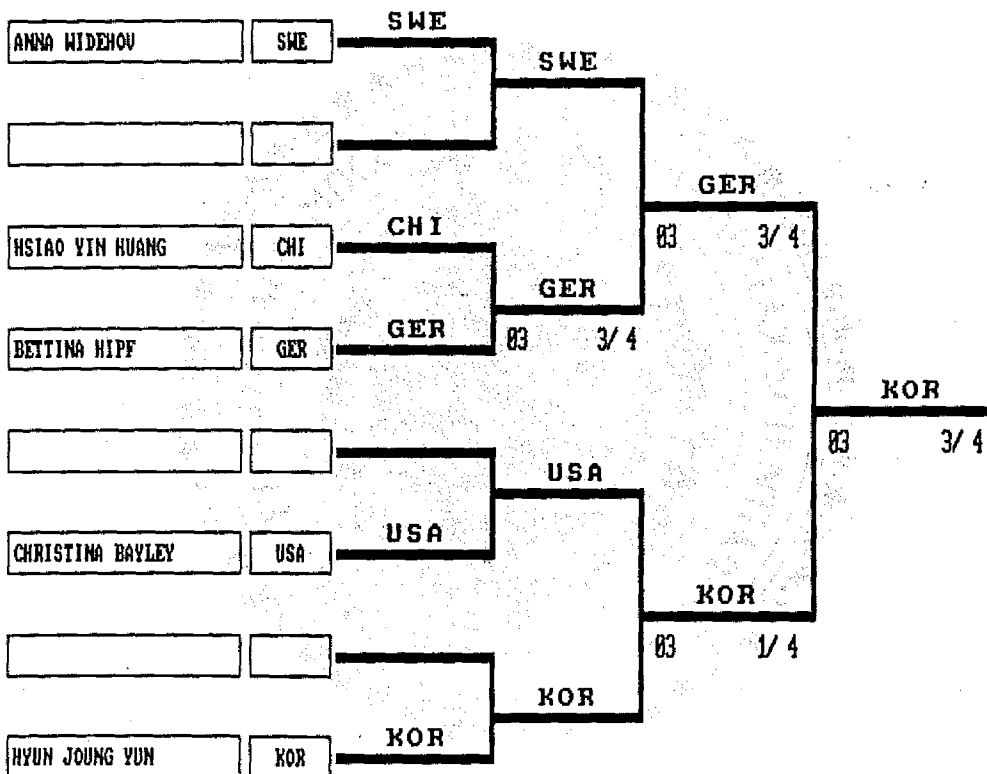

| | |
|-----------|---------|
| GANADORES | |
| GAGNANTS | WINNERS |

- | | |
|----------------------|-----|
| 1.- HYUN JOUNG YUN | KOR |
| 2.- BETTINA HIPF | GER |
| 3.- CHRISTINA BAYLEY | USA |
| 3.- ANNA WIDEHOU | SWE |

| | | | | | |
|-------------------------------------|----------------------|--|-----------------------------------|--|--|
| 01 KNOK OUT KNOK OUT KNOK OUT | 02 RSC RSC RSC | 03 PUNTOS/SUPERIORIDAD POINT /SUPERIORITE POINTS/SUPERIORITY | 04 RETIRO RETRAITE WITHDRAW | 05 DESCALIFICACION DISQUALIFICATION DISQUALIFIED | 06 DEDUCCION DEDUCCION DEDUCCION |
|-------------------------------------|----------------------|--|-----------------------------------|--|--|