

TOURNOI PAR EQUIPES - TEAM TOURNAMENT

QUALIFICATIONS

FEMMES - WOMEN

Groupe A					Groupe B											
				Pts	Set	Pl.				Pts	Set	Pl.				
1.	KOR	xxx	3-1	3-0	2	5-1	1	1.	URS	xxx	3-1	3-1	3-0	3	9-1	1
2.	HUN	1-3	xxx	1-3	0	2-6	3	2.	CAN	0-3	xxx	2-3	3-1	1	5-7	3
3.	YUG	0-3	3-1	xxx	1	3-4	2	3.	POL	1-3	3-2	xxx	3-0	2	7-5	2
								4.	SUI	0-3	1-3	0-3	xxx	0	1-9	4

Groupe C					Groupe D										
				Pts	Set	Pl.				Pts	Set	Pl.			
1.	JPN	xxx	3-0	1-3	1	4-3	2	1.	CHN	xxx	3-0	3-0	2	6-0	1
2.	FRG	0-3	xxx	1-3	0	1-6	3	2.	TCH	0-3	xxx	3-1	1	3-4	2
3.	BUL	3-1	3-1	xxx	2	6-2	1	3.	GBR	0-3	1-3	xxx	0	1-6	3

HOMMES - MEN

Groupe A					Groupe B													
				Pts	Set	Pl.				Pts	Set	Pl.						
1.	POL	xxx	5-0	5-0	5-0	3	15-0	1	1.	FRG	xxx	0-5	2-5	5-1	5-1	2	12-12	3
2.	SUI	0-5	xxx	5-0	1-5	1	6-10	3	2.	JPN	5-0	xxx	3-5	5-0	5-0	3	18- 5	2
3.	HUN	0-5	0-5	xxx	3-5	0	3-15	4	3.	BUL	5-2	5-3	xxx	5-0	5-0	4	20- 5	1
4.	GBR	0-5	5-1	5-3	xxx	2	10-8	2	4.	FIN	1-5	0-5	0-5	xxx	5-0	1	6-15	4
									5.	LBA	1-5	0-5	0-5	0-5	xxx	0	1-20	5

Groupe C					Groupe D												
				Pts	Set	Pl.				Pts	Set	Pl.					
1.	CHN	xxx	5-0	5-0	5-0	3	15-0	1	1.	KOR	xxx	4-5	5-0	5-1	2	14-6	2
2.	CAN	0-5	xxx	1-5	5-3	1	16-13	3	2.	URS	5-4	xxx	5-0	5-0	3	15-4	1
3.	TCH	0-5	5-1	xxx	5-0	2	10-6	2	3.	SYR	0-5	0-5	xxx	0-5	0	0-15	4
4.	HOL	0-5	3-5	0-5	xxx	0	3-15	4	4.	YUG	1-5	0-5	5-0	xxx	1	6-10	3



TOURNOI PAR EQUIPES - TEAM TOURNAMENT

FEMMES - WOMEN

Finales-Finals

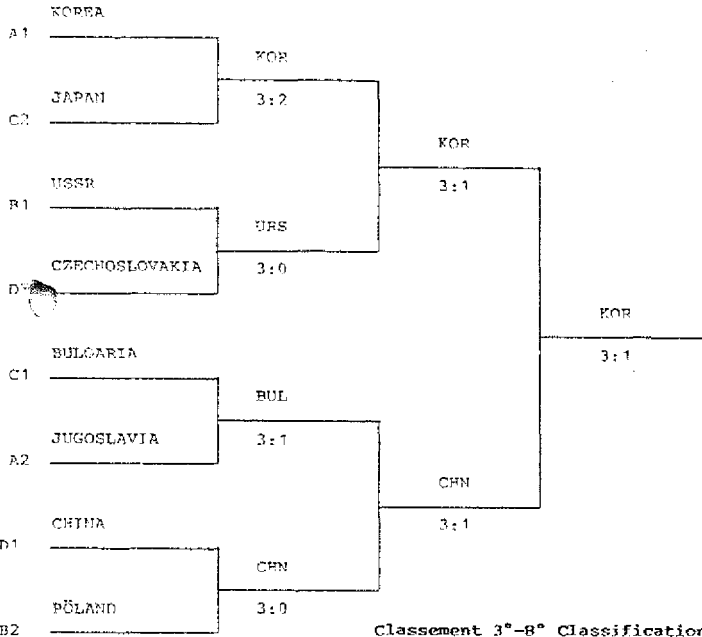

Classement final
Final classification

1. KOR
2. CHN
3. URS
4. BUL
5. YUG
6. JPN
7. POL
8. TCH
9. FRG
10. HUN
11. CAN
12. GBR
13. SUI

Classement 3°-8° Classification
USSR

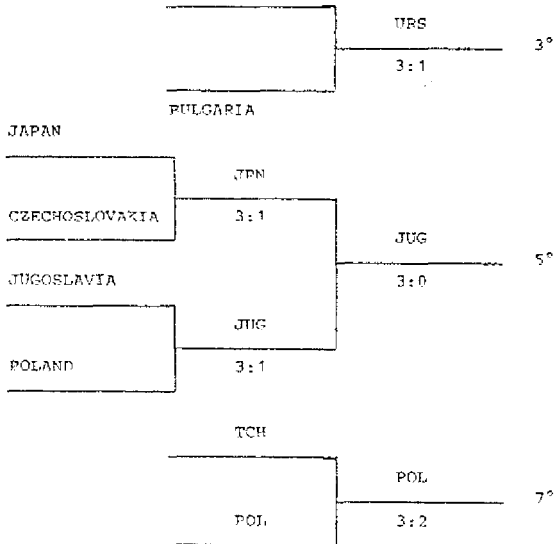

TOURNOI PAR EQUIPES - TEAM TOURNAMENT

HOMMES - MEN

Finales-Finals

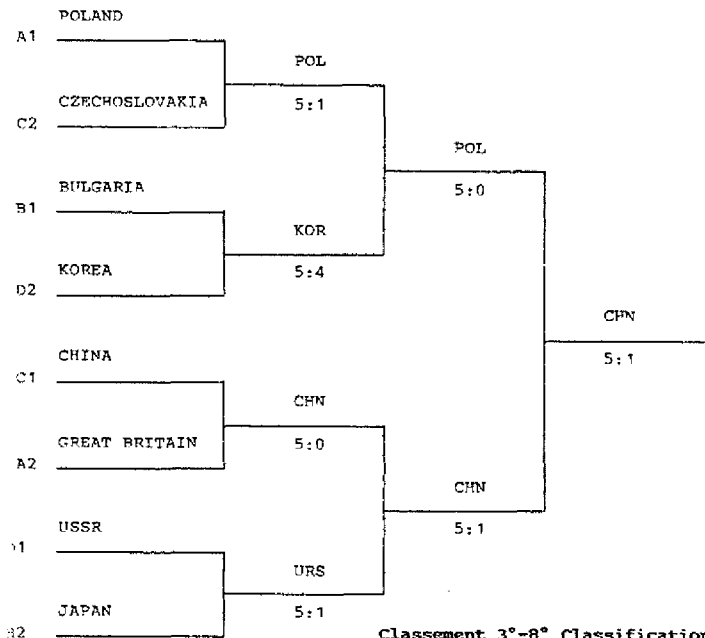

Classement final
Final classification

1. CHN
2. POL
3. URS
4. KOR
5. BUL
6. JPN
7. TCH
8. GBR
9. FRG
10. CAN
11. YUG
12. SUI
13. HOL
14. FIN
15. SYR
16. HUN
17. LBA
18. VEN

Classement 3°-8° Classification

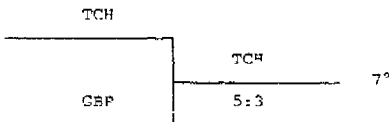
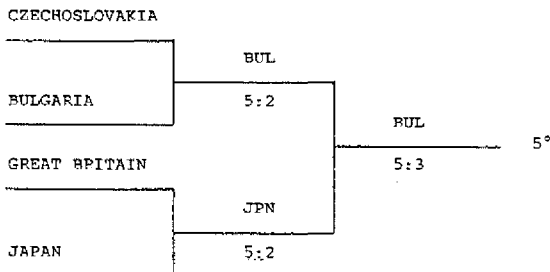
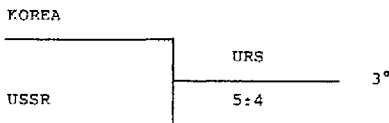

TOURNOI PAR EQUIPES - TEAM TOURNAMENT

CONSOLATIONS

HOMMES - MEN

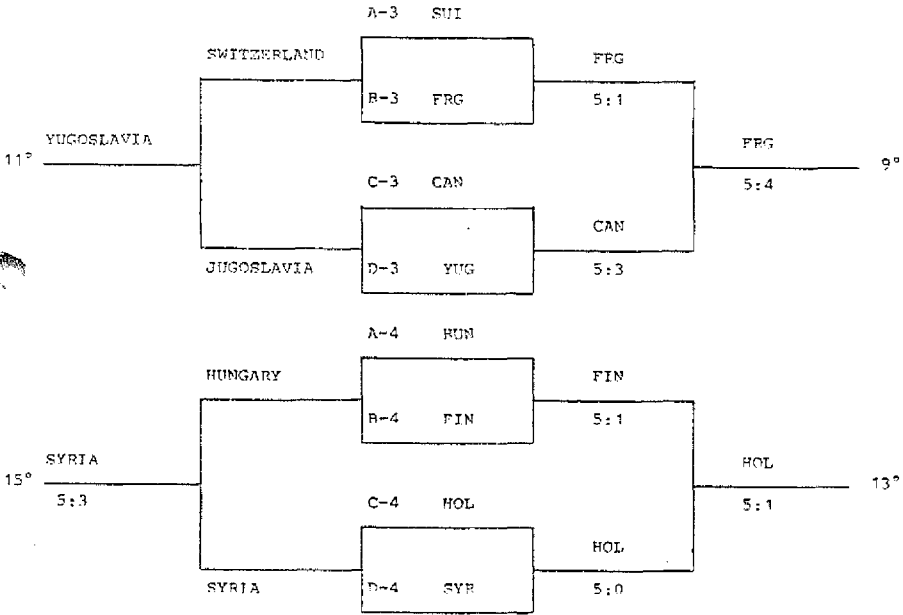

17° Place : LBA

FEMMES - WOMEN

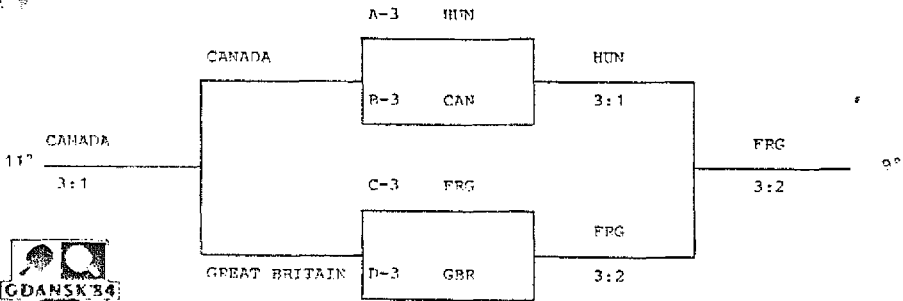

13° Place : SUI



FEMMES-WOMEN

SIMPLES - SINGLES
Groupe A

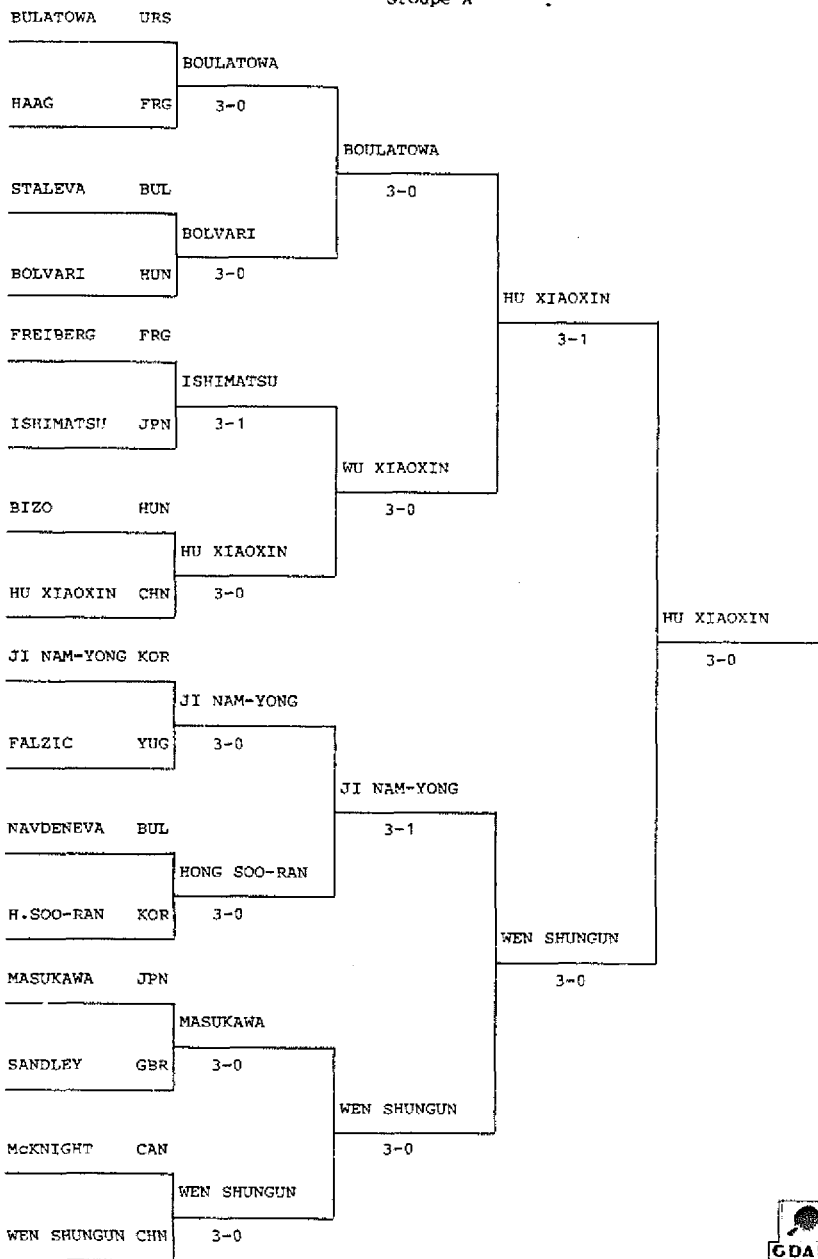

FEMMES-WOMEN

-41-

SIMPLES - SINGLES
Groupe B

GUERGUELTCHÉVA BUL

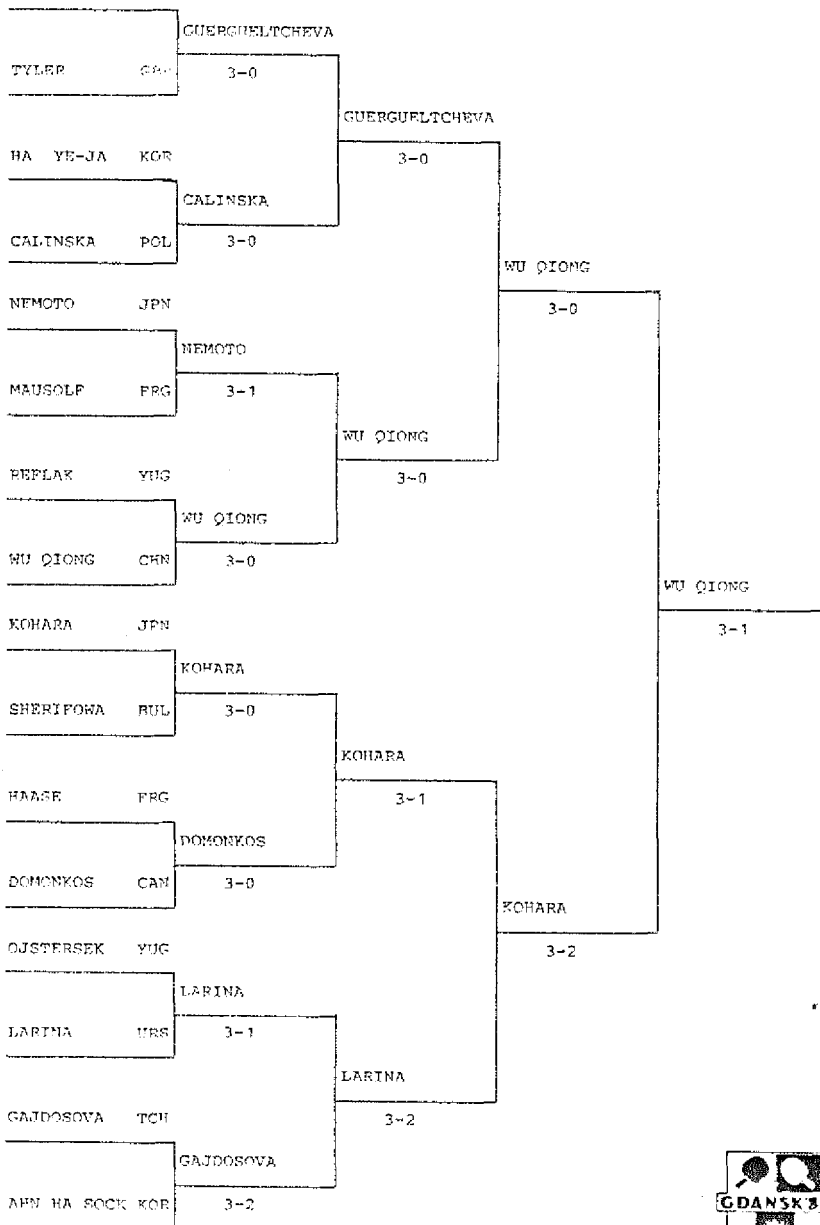

HOMMES-MEN

SIMPLES - SINGLES
Groupe A

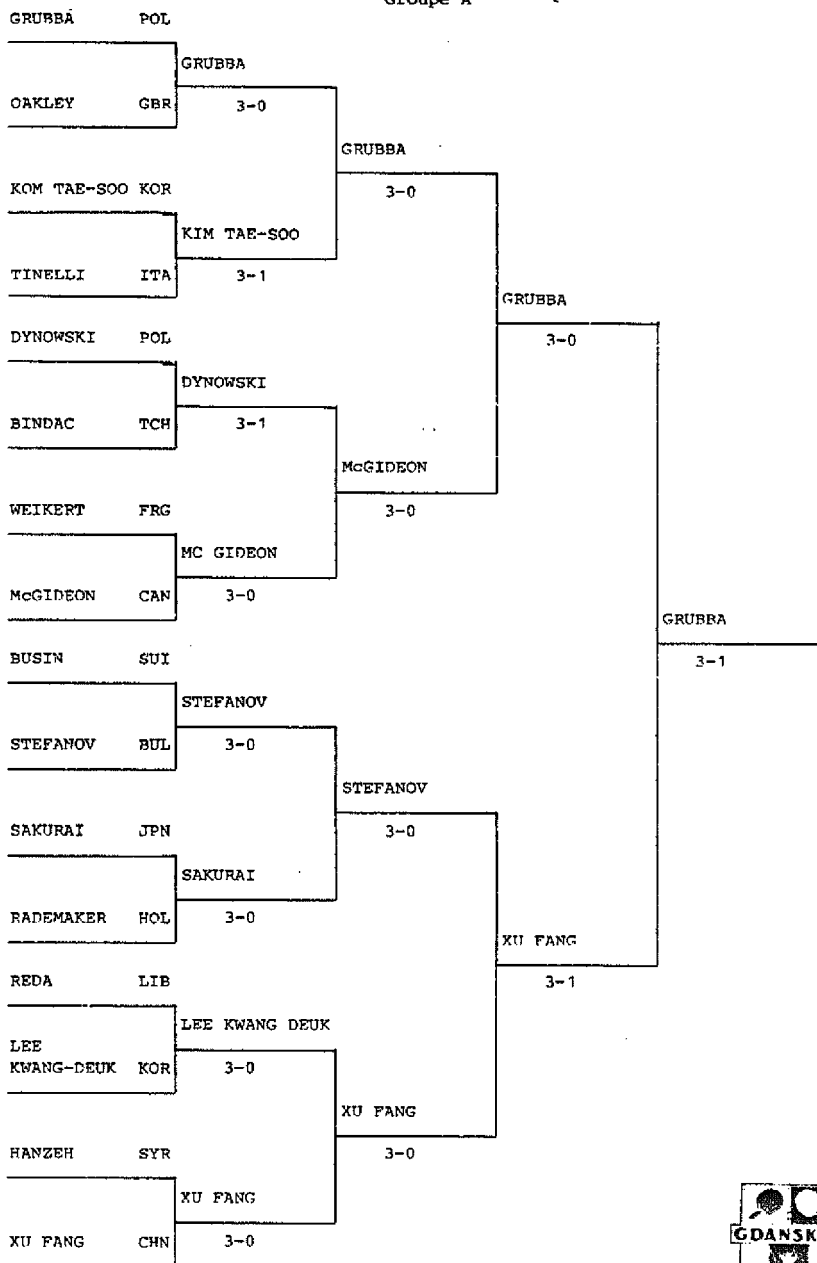

HOMMES-MEN

-43-
SIMPLES - SINGLES
Groupe B

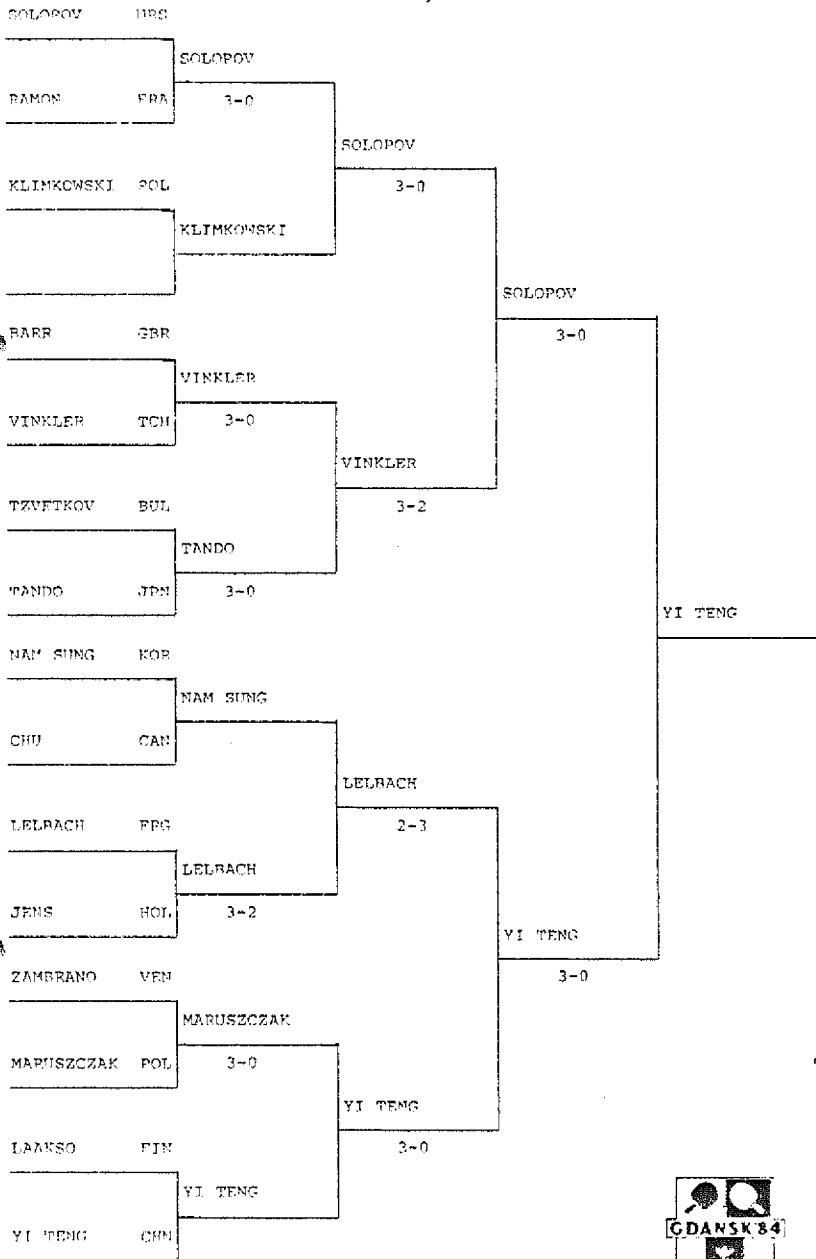



RULATOWA/GUERGUELTCHEVA

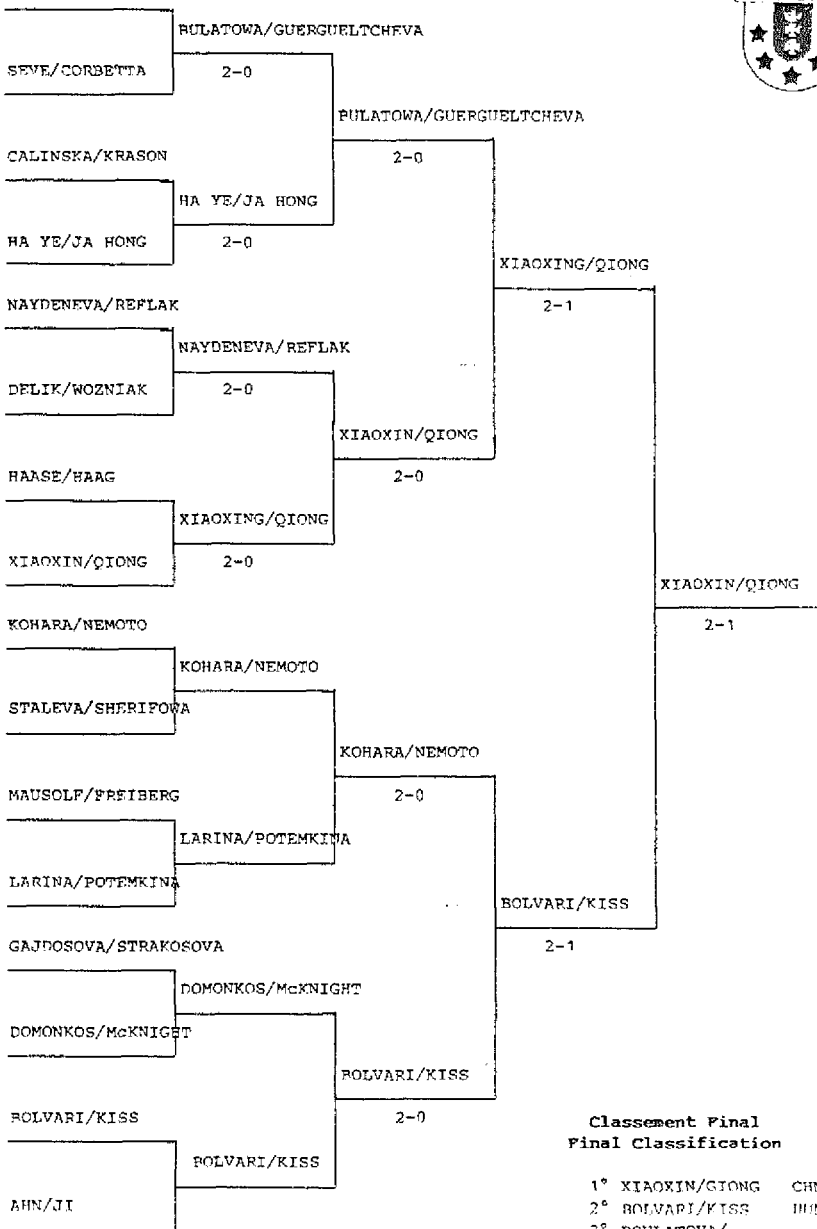

Classement Final
Final Classification

- 1° XIAOXIN/QIONG CHN
- 2° BOLVARI/KISS HUN
- 3° RULATOWA/GUERGUELTCHEVA BUL
- 4° KOHARA/NEMOTO JPN



GRUBBA/JAKUBOWICZ

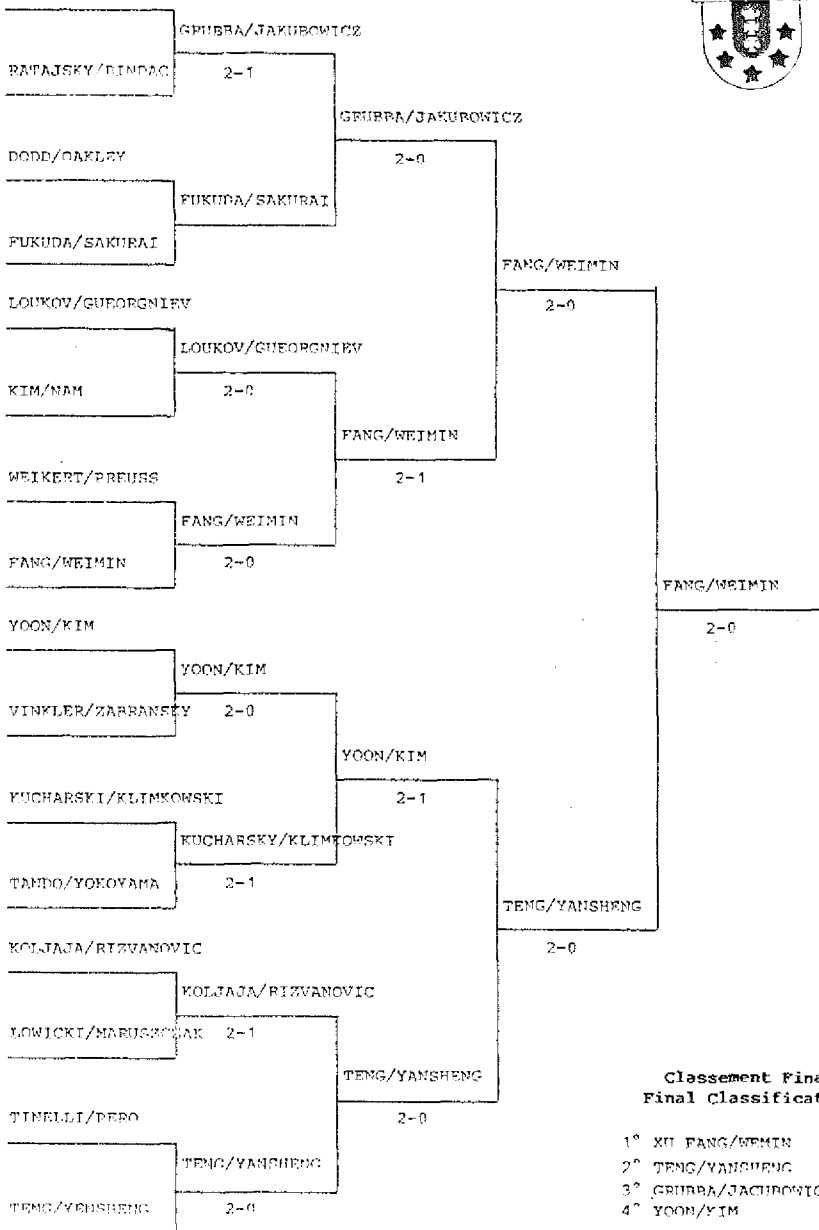

Classement Final
Final Classification

- 1° XU FANG/WEIMIN CHN
- 2° TENG/YANSHENG CHN
- 3° GRUBBA/JAKUBOWICZ POL
- 4° YOON/YIM KOR

GRUEBA/CALINSKA

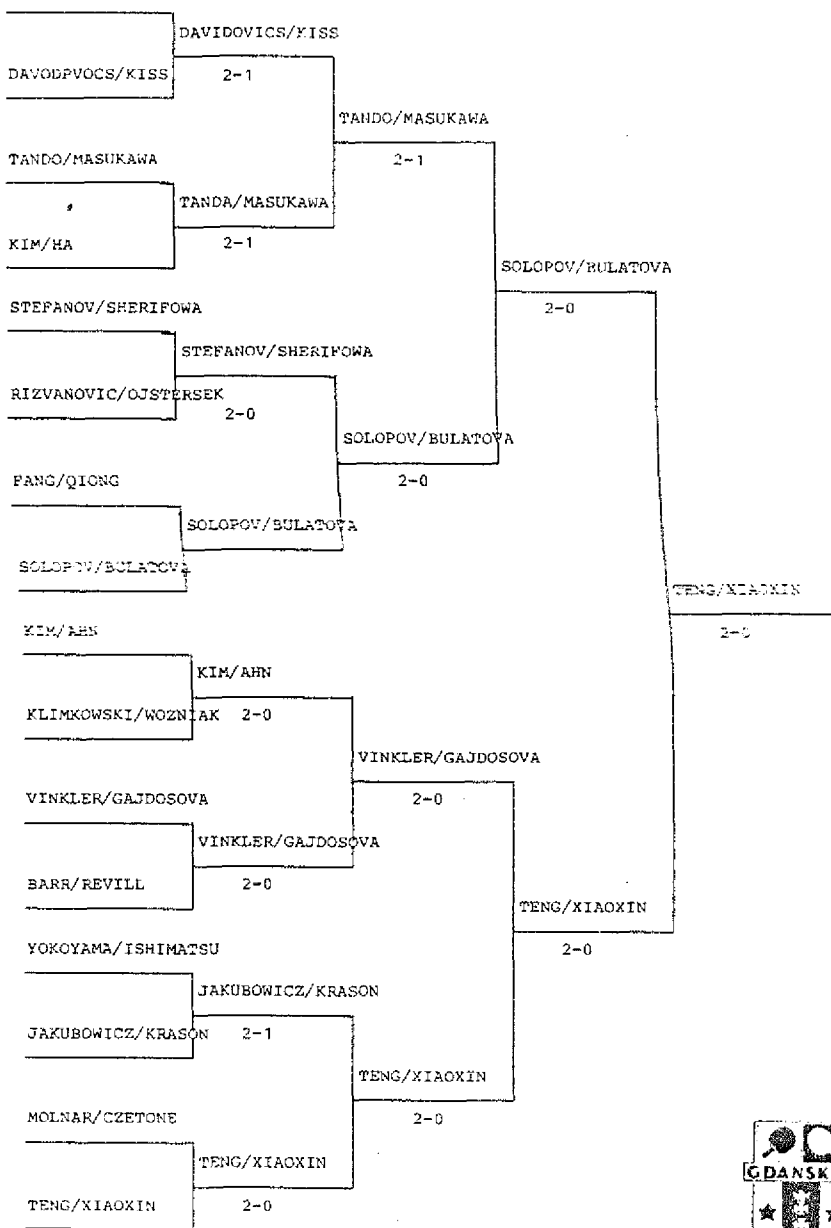

MIXTES-MIXED

-49-
DOUBLES
Groupe B

YANGSHENG/SHUNGUN

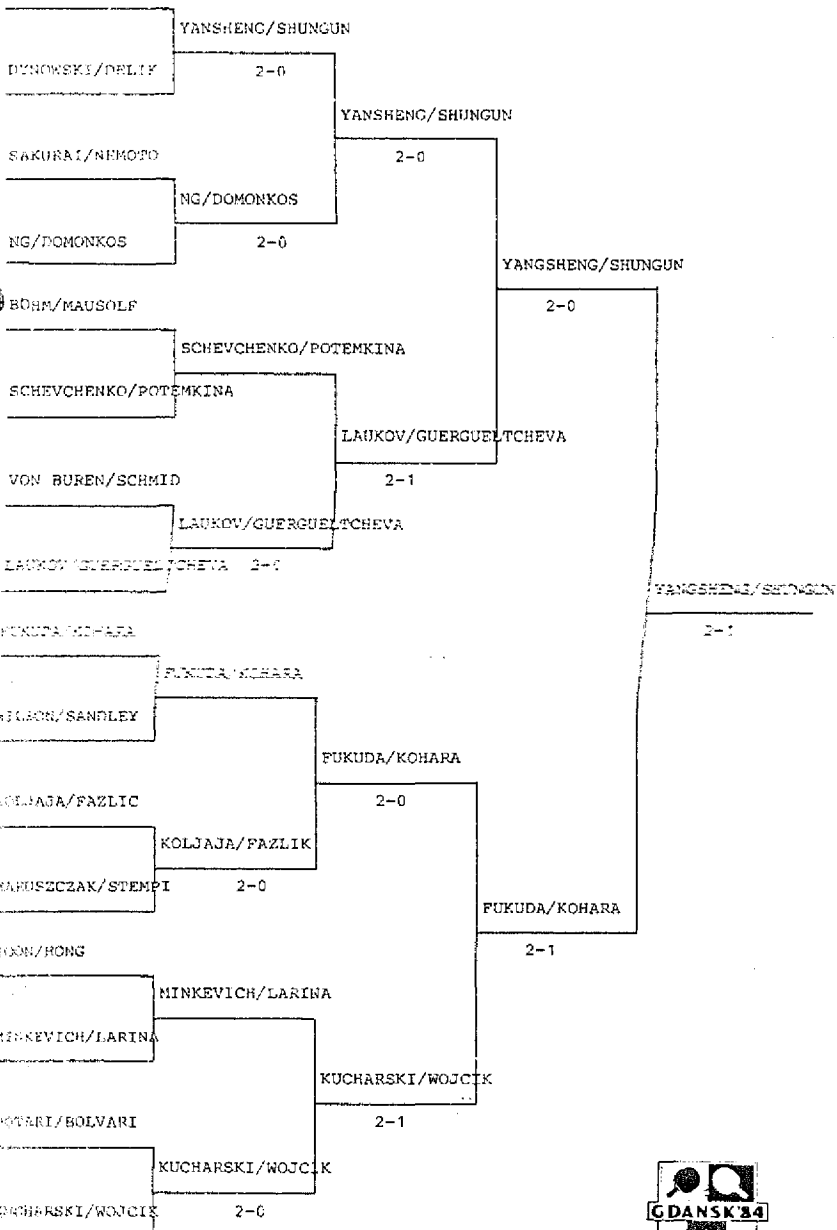

TOURNOI INDIVIDUEL - INDIVIDUAL TOURNAMENT

HOMMES-MEN

FEMMES - WOMEN

Finales-Finals

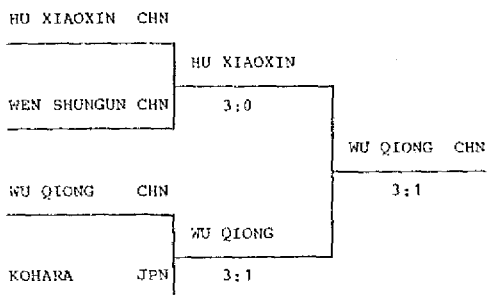

Classement final
Final classification

1. WU QIONG CHN
2. XIAOXIN HU CHN
3. KOHARA Rumi JPN
4. WEN SHUNGUN CHN

HOMMES - MEN

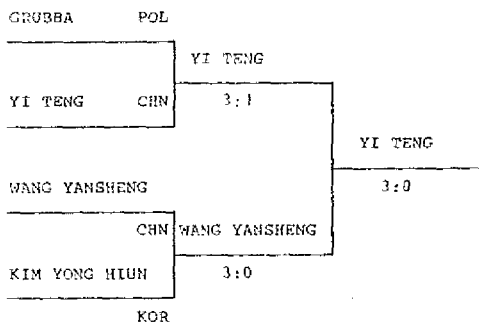

Classement final
Final classification

1. YI TENG CHN
2. WANG YANSHENG CHN
3. GRUBBA A. POL
4. KIM YONG HYUN KOR

DOUBLES MIXTES-MIXED DOUBLES

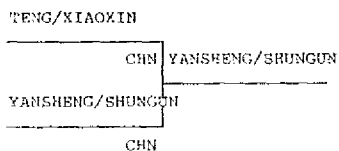

Classement final
Final classification

1. YANSHENG/SHUNGUN CHN
2. YI TENG/XIAOXIN CHN
3. FUKUOA/KOHARA JPN
4. SOLOPOV/SULATOVA URS





L'équipe vainqueur honorée par S. COELMO, délégué du comité exécutif.
The winning korean team honored by S. COELMO.

TOURNOI PAR EQUIPES - TEAM TOURNAMENT
HOMMES-MEN

CLASSEMENT PRELIMINAIRE PRELIMINARY CLASSIFICATION			
Groupe A	Groupe B	Groupe C	Groupe D
1. POL	1. BUL	1. CHN	1. URS
2. GBR	2. JPN	2. TCH	2. KOR
3. SUI	3. FRG	3. CAN	3. YUG
4. HUN	4. FIN	4. HOL	4. SYR
	5. LBA		
DEMI-FINALES SEMI FINALS	FINALES FINALS	CLASSIFICATIONS	
POL 5-0 KOR	CHN 5-1 POL	3 ⁴ ° KOR 4 - 5 URS	11 ¹² ° YUG 5 - 4 SUI
URS 1-5 CHN		5 ⁶ ° JPN 3 - 5 BUL	13 ¹⁴ ° FIN 1 - 5 HOL
		7 ⁸ ° TCH 5 - 3 GBR	15 ¹⁶ ° HUN 3 - 5 SYR
		9 ¹⁰ ° FRG 5 - 4 CAN	17 ¹⁸ ° LBA 5 - 4 VEN

FEMMES-WOMEN

CLASSEMENT PRELIMINAIRE PRELIMINARY CLASSIFICATION			
Groupe A	Groupe B	Groupe C	Groupe D
1. KOR	1. URS	1. BUL	1. CHN
2. HUN	2. POL	2. JPN	2. TCH
3. YUG	3. CAN	3. FRG	3. GBR
	4. SUI		
DEMI-FINALES SEMI FINALS	FINALES FINALS	CLASSIFICATIONS	
URS 1-3 KOR	CHN 1-3 KOR	3 ⁴ ° BUL 1 - 3 URS	9 ¹⁰ ° FRG 3 - 2 POL
CHN 3-1 BUL		5 ⁶ ° YUG 3 - 0 JPN	11 ¹² ° CAN 3 - 1 GBR
		7 ⁸ ° TCH 2 - 3 POL	

Dans le tournoi par équipe des femmes, il y avait finalement 13 équipes divisées en 4 groupes, A,B,C,D. Elles jouaient suivant le système d'«élimination directe», 8 équipes, 2 de chaque groupe jouant selon le système de poule passaient aux jeux pour la place I-VIII. Ces équipes qui avaient gagné la troisième place jouaient entre elles, suivant le système de poule, pour les places IX-XII.

Dans le tournoi par équipe des hommes 17 équipes divisées en 4 groupes jouaient suivant le système d'«élimination directe». 8 équipes, 2 pour chaque groupe, suivant le système de poule, passaient aux jeux pour la I-VIII places. Ces équipes qui avaient gagné la troisième place dans leurs groupes jouaient entre elles, suivant le système de poule pour la place IX-XII. Celles qui avaient gagné la quatrième place luttait pour les XIII-XVI positions.

In women team tournament there were 13 teams, divided into 4 groups. In groups the teams competed «each versus each» system. Advancement to the next games for places from I-VIII, gained 8 teams - two from each group which were playing the «cup system». Teams, which gained the 3rd places in their groups, were playing for places IX-XII, «cup system» as well.

In men teams tournament there were 17 teams, divided into 4 groups: In groups the teams competed «each versus each» system. Advancement to the next games for places from I-VIII, gained 8 teams - two from each group - which were playing the «cup» system. Teams which gained the 3rd places in their groups, were playing for places IX-XII «cup» system as well. And those which got the 4th places in their groups for places XIII-XVI in the whole championships.

HOMMES-MEN

CLASSEMENT FINAL -FINAL CLASSIFICATION					
1. CHN	2. POL	3. URS	4. KOR	9. FRG	14. FIN
XU FANG	GRUBBA	SOLOPOV	5. BUL	10. CAN	15. SYR
WANG YANSHENG	JAKUBOWICZ	SZEWCZENKO	6. JPN	11. YUG	16. HUN
YI TENG	KUCHARSKI	MINKIEWICZ	7. TCH	12. SUI	17. LBA
			8. GBR	13. HOL	18. VEN

FEMMES-WOMEN

CLASSEMENT FINAL -FINAL CLASSIFICATION					
1. KOR	2. CHN	3. URS	4. BUL	9. FRG	
AN HAE-SOOK	WU-QIONG	LARINA	5. YUG	10. HUN	
JI NAM-YONG	WEN SHUNGUN	BULATOWA	6. JPN	11. CAN	
	HU XIAOXIN	POTIOMKINA	7. POL	12. GBR	
			8. TCH	13. SUI	

